



# CONVERSION

# CONF

JUNE 2024 /  
KYIV, UKRAINE



# CONVERSION CONF

KYIV

**JUNE 2024**

JOIN US TO BE INSPIRED BY TEN DYNAMIC SPEAKERS, EACH DELIVERING INSIGHTFUL TALKS ON VARIOUS ASPECTS OF AFFILIATE MARKETING, ENJOY THE SPONSOR STANDS AND GAIN NEW CONNECTIONS.

EXPECT AN ELECTRIC ATMOSPHERE, WHERE LIKE-MINDED PROFESSIONALS UNITE TO SHARE IDEAS, DISCUSS THE LATEST TRENDS, AND UNCOVER FRESH BUSINESS PROSPECTS.

# CONVERSION CLUB

## EVENT MAP 2024

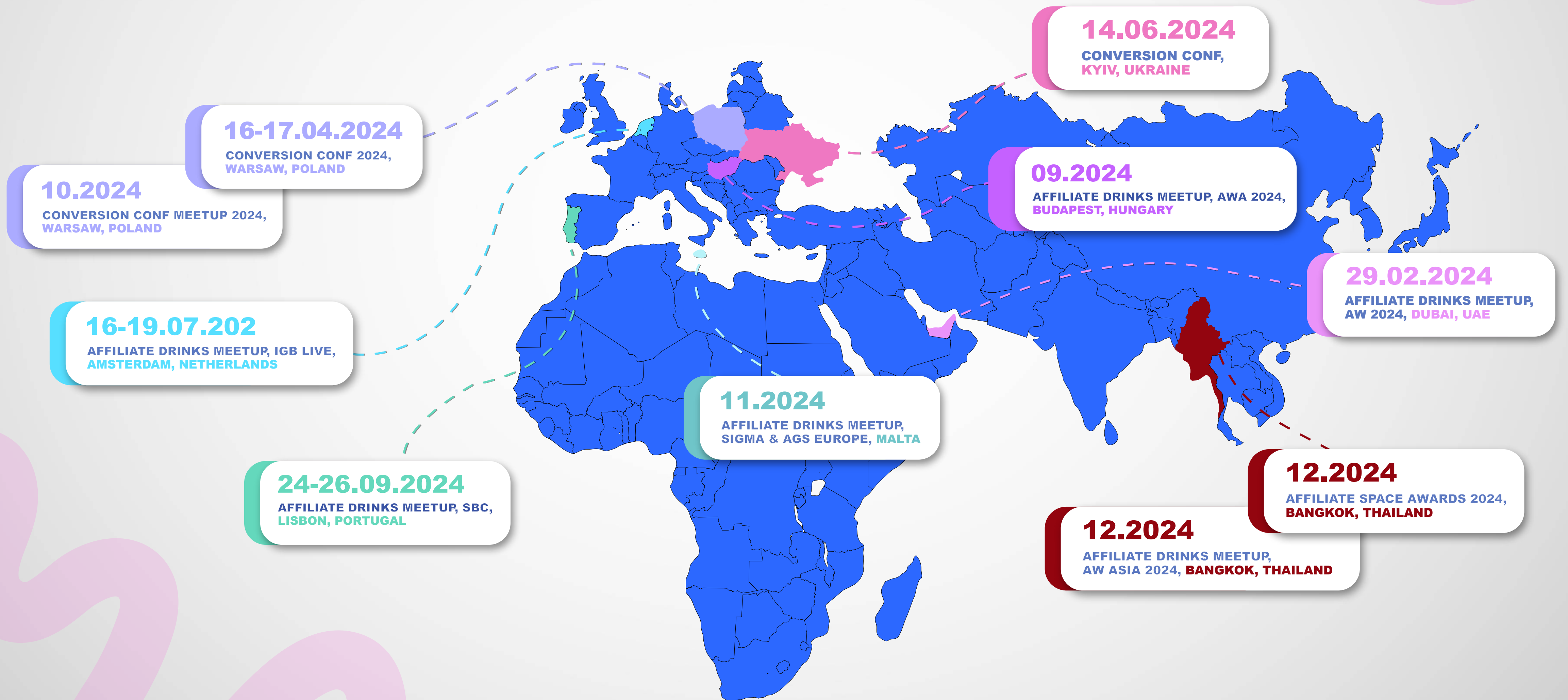

# CONFERENCE MAP

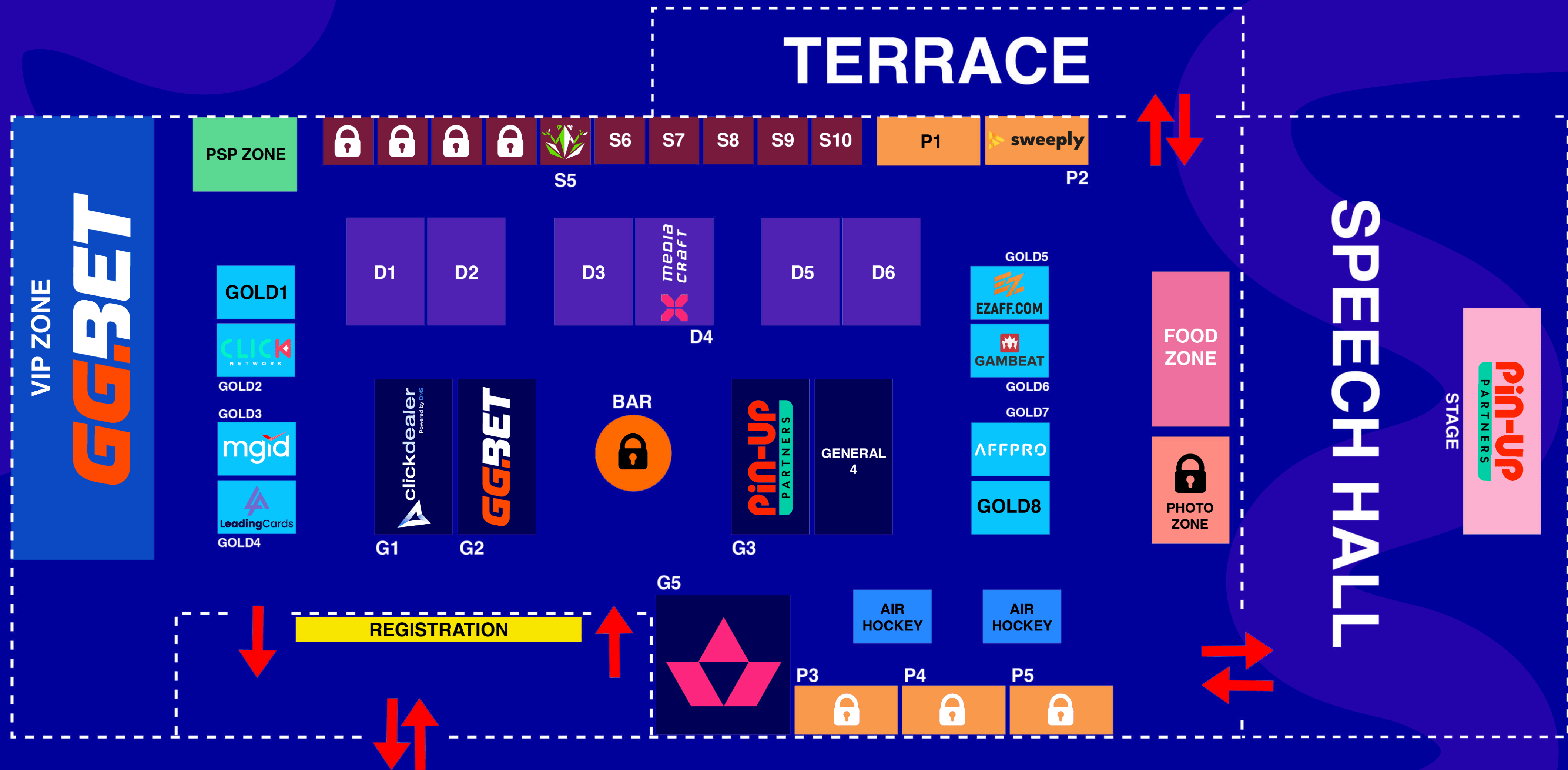

**STAGE**

**USD 8000**

**SPONSOR**

## What does this package offer?

- 8 VIP entrance tickets for your team members only;
- 8 silver tickets for affiliates;
- 2 X-banners 180\*80 with your logo and QR code placed in the event venue;
- 8 branded vertical banners next to the stage;
- branded stage desk with your logo and QR code placed in the event venue;
- branded G-flag 2 units;
- model accreditation (where you bring your promo models and we provide passes for them during the conference);
- giveaway opportunity;
- watermarked photos and videos from the event with your logo;
- your logo on the press wall of the photo zone;
- amazing atmosphere and networking during the party;
- sponsorship announcement on the website + social media (audience of 60k+ marketers).



**MAJOR**

**USD 7600**

**SPONSOR**

## What does this package offer?

- 7 VIP entrance tickets for your team members only;
- 7 silver tickets for affiliates;
- branded big banner at the event venue;
- 2 X-banners 180\*80 with your logo and QR code placed in the event venue;
- 2 branded vertical banners;
- branded G-flag 2 units;
- model accreditation (where you bring your promo models and we provide passes for them during the conference);
- giveaway opportunity;
- watermarked photos and videos from the event with your logo;
- your logo on the press wall of the photo zone;
- amazing atmosphere and networking during the party;
- sponsorship announcement on the website + social media (audience of 60k+ marketers).



**BADGE**

**USD 5000**

**SPONSOR**



## What does this package offer?

- 5 VIP entrance tickets for your team members only;
- 5 silver tickets for affiliates;
- branded badges for all attendees;
- 1 X-banner 180\*80 with your logo and QR code placed in the event venue;
- watermarked photos and videos from the event with your logo;
- your logo on the press wall of the photo zone;
- amazing atmosphere and networking party;
- sponsorship announcement on the conference website + social media (audience of 60k+ marketers).

**BAR**

**USD 5000**

**SPONSOR**



## What does this package offer?

- 5 VIP entrance tickets for your team members only;
- 5 silver tickets for affiliates;
- branded bar desk with your logo placed in the event venue;
- 2 branded bartender T-shirts with your logo;
- your logo on the coasters for the bar and tables (100 units);
- 1 X-banner 180\*80 with your logo and QR code placed in the event venue;
- watermarked photos and videos from the event with your logo;
- your logo on the press wall of the photo zone;
- amazing atmosphere and networking during the party;
- sponsorship announcement on the website + social media (audience of 60k+ marketers).



# REGISTRATION

**USD 5000**

# SPONSOR



## What does this package offer?

- 4 VIP entrance tickets for your team members only;
- 4 silver tickets for affiliates;
- branded reception desk with your logo and QR code placed in the event venue;
- 2 branded reception T-shirts with your logo;
- 1 X-banner 180\*80 with your logo and QR code placed in the event venue;
- watermarked photos and videos from the event with your logo;
- your logo on the press wall of the photo zone;
- amazing atmosphere and networking during the party;
- sponsorship announcement on the website + social media (audience of 60k+ marketers).

VIP ZONE

USD 5000

SPONSOR

## What does this package offer?

- 5 VIP entrance tickets for your team members only;
- 5 silver tickets for affiliates;
- branded bar with your logo in the VIP zone;
- branded tables in the VIP zone;
- 2 branded staff T-shirts with your logo;
- your table business card in the VIP zone;
- your logo on the bar/table coasters (100 units) in the VIP zone;
- VIP zone fence with your logo inside;
- big branded balloons with your logo (4 units);
- your logo on the press wall of the photo zone;
- watermarked photos and videos from the event with your logo;
- amazing atmosphere and networking during the party;
- sponsorship announcement on the website + social media (audience of 60k+ marketers).

VIP  
SOLD OUT

# PHOTOZONE

**USD 4500**

## SPONSOR



### What does this package offer?

- 4 VIP entrance tickets for your team members only;
- 4 silver tickets for affiliates;
- branded photo zone with your company logo;
- watermarked photos and videos from the event with your logo;
- your logo on the press wall of the photo zone;
- amazing atmosphere and networking during the party;
- sponsorship announcement on the conference website + social media (audience of 60k+ marketers).

**PS SPONSOR**

**USD 4000**

### **What does this package offer?**

- 4 VIP entrance tickets for your team members only;
- 4 silver tickets for affiliates;
- PlayStation zone with 2 X-banners 180\*80 with your logo and QR code placed at the event venue;
- 2 staff members in branded T-shirts with your company logo;
- watermarked photos and videos from the event with your logo;
- your logo on the press wall of the photo zone;
- amazing atmosphere and networking during the party;
- sponsorship announcement on the website + social media (audience of 60k+ marketers).



# AIR HOCKEY

**USD 4000**

**SPONSOR**

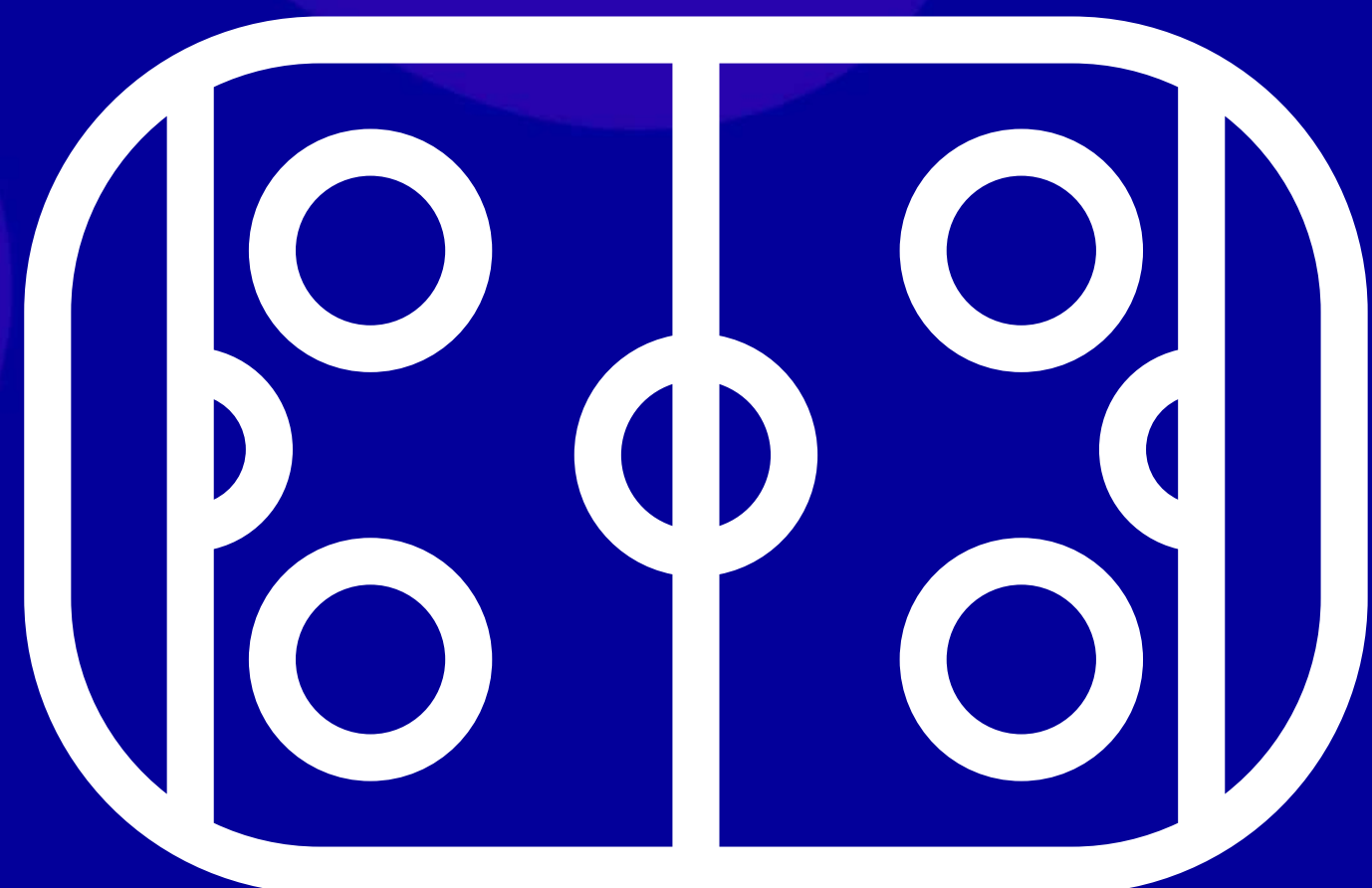

## What does this package offer?

- 4 VIP entrance tickets for your team members only;
- 4 silver tickets for affiliates;
- air hockey zone with 2 X-banners 180\*80 with your logo and QR code placed at the event venue;
- 2 staff members in branded T-shirts with your company logo;
- watermarked photos and videos from the event with your logo;
- your logo on the press wall of the photo zone;
- amazing atmosphere and networking during the party;
- sponsorship announcement on the website + social media (audience of 60k+ marketers).

GAME

SPONSOR

**USD 4000**

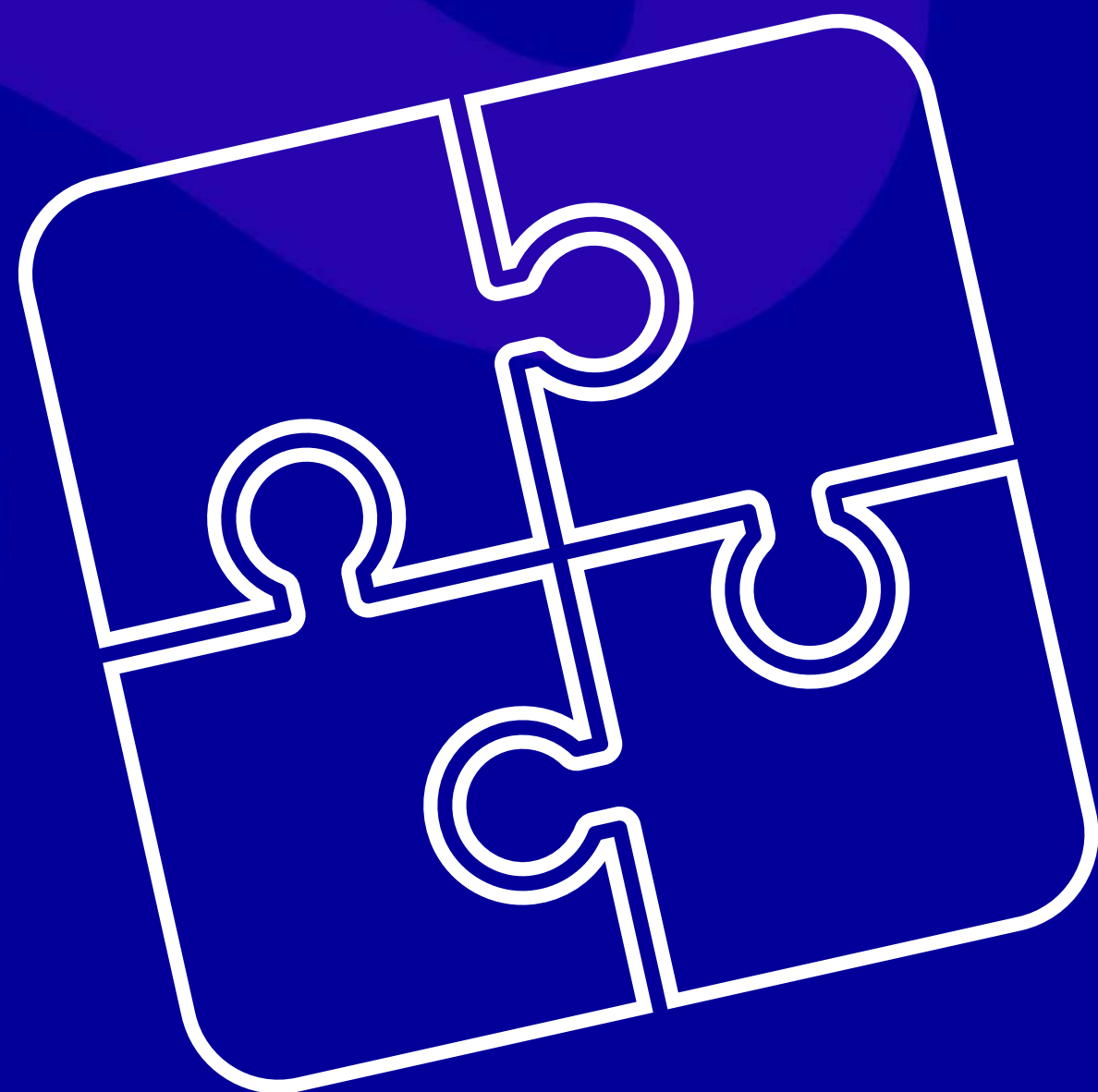

## What does this package offer?

- 4 VIP entrance tickets for your team members only;
- 4 silver tickets for affiliates;
- branded the claw machine;
- branded cash Cube Booth;
- 2 staff members in branded T-shirts with your company logo;
- watermarked photos and videos from the event with your logo;
- your logo on the press wall of the photo zone;
- amazing atmosphere and networking during the party;
- sponsorship announcement on the website + social media (audience of 60k+ marketers).

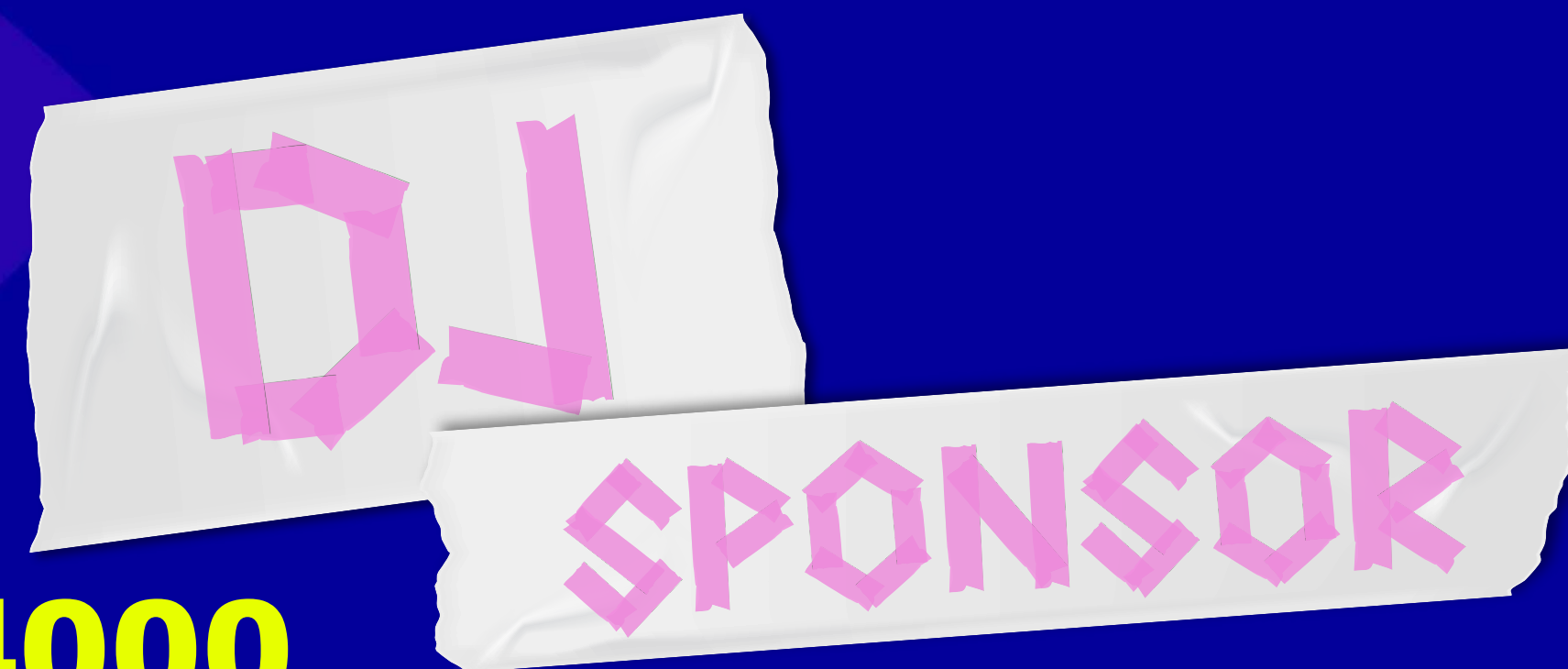

**USD 4000**



## What does this package offer?

- 4 VIP entrance tickets for your team members only;
- 4 silver tickets for affiliates;
- 1 X-banner 180\*80 with your logo and QR code placed in the event venue;
- branded DJ desk with your logo and QR code placed in the event venue;
- 1 branded T-shirt with your logo on DJ ;
- watermarked photos and videos from the event with your logo;
- your logo on the press wall of the photo zone;
- amazing atmosphere and networking during the party;
- sponsorship announcement on the website + social media (audience of 60k+ marketers).

EXCLUSIVE

USD 3000

PHOTOZONE

SPONSOR

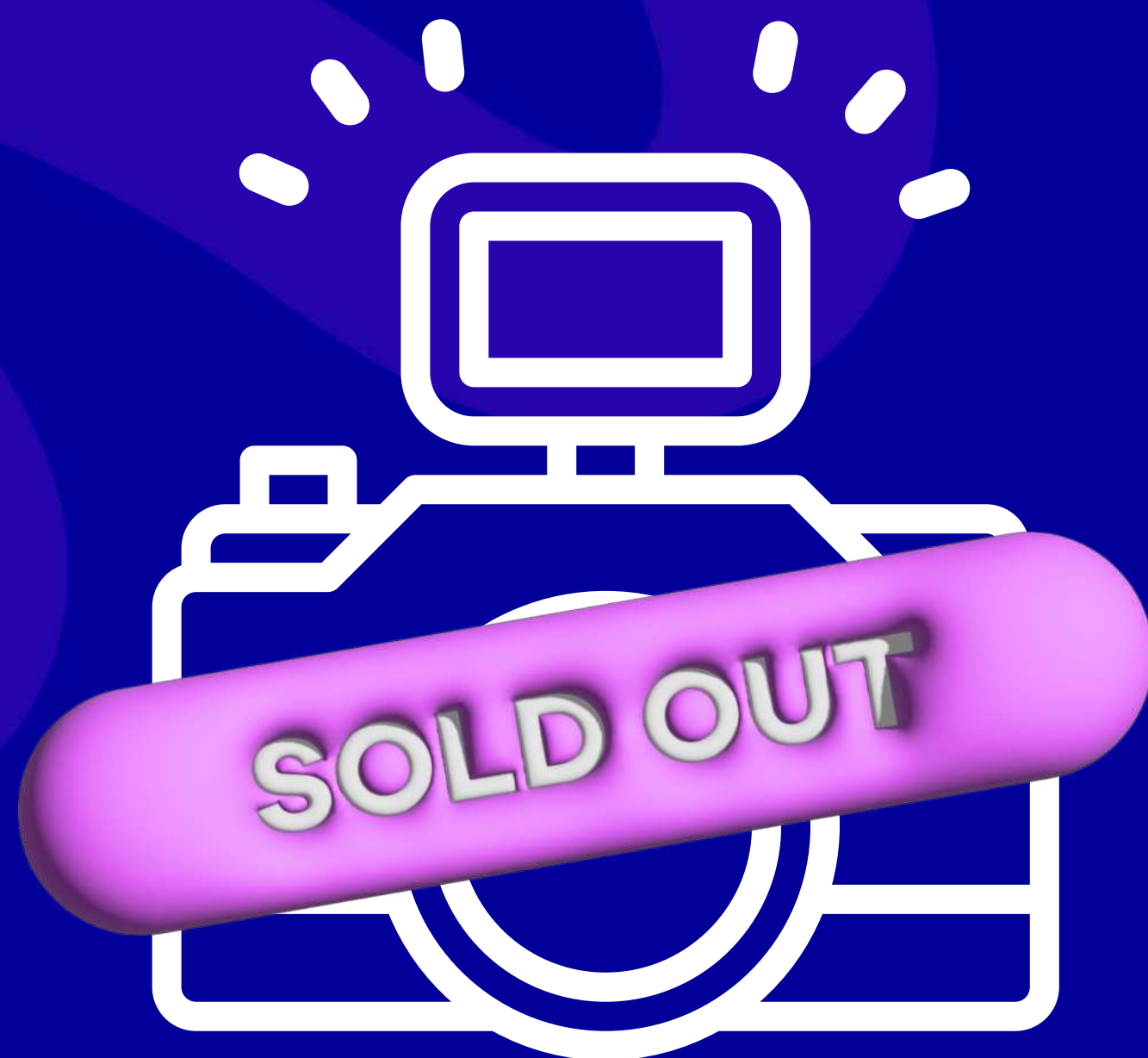

## What does this package offer?

- 3 VIP entrance tickets for your team members only;
- 2 silver tickets for affiliates;
- 12 m2 of your space (4x3 m);
- photo zone based on your specifications, with expenses covered by you watermarked photos and videos from the event with your logo;
- your logo on the press wall of the photo zone;
- amazing atmosphere and networking during the party;
- sponsorship announcement on the conference website + social media (audience of 60k+ marketers).



WRISTBANT

USD 3000

SPONSOR



## What does this package offer?

- 3 VIP entrance tickets for your team members only;
- 2 silver tickets for affiliates;
- your logo on the event wristbands;
- watermarked photos and videos from the event with your logo;
- your logo on the press wall of the photo zone;
- amazing atmosphere and networking during the party;
- sponsorship announcement on the website + social media (audience of 60k+ marketers).

**BALLOONS**

**USD 2000**

**SPONSOR**



## **What does this package offer?**

- 2 VIP entrance tickets for your team members only;
- 2 silver tickets for affiliates;
- branded balloons all over the venue;
- branded photo zone with your company logo;
- watermarked photos and videos from the event with your logo;
- your logo on the press wall of the photo zone;
- amazing atmosphere and networking during the party;
- sponsorship announcement on the website + social media (audience of 60k+ marketers).

# GENERAL SPONSOR

**USD 8000 FOR AFTERPARTY**



## What does this package offer?

- 6 VIP entrance tickets for your team members only;
- 6 silver tickets for affiliates;
- conference VIP table for 6 persons in the VIP zone;
- afterparty VIP table for 6 persons with luxury alcohol and snacks, private hookah for your team;
- branded G-flag 2 units;
- 2 branded bartender T-shirts with your logo at the afterparty;
- table tents with your logo, description, and QR code for each table;
- your logo on the stream screen at the afterparty;
- watermarked photos and videos from the event with your logo;
- your logo on the press wall of the photo zone;
- amazing atmosphere and networking during the party;
- sponsorship announcement on the website + social media (audience of 60k+ marketers).

interested? contact us right now!  
\*booking deadlines: 7 days before the event

# HOOKAH SPONSOR

USD 5000 **FOR AFTERPARTY**

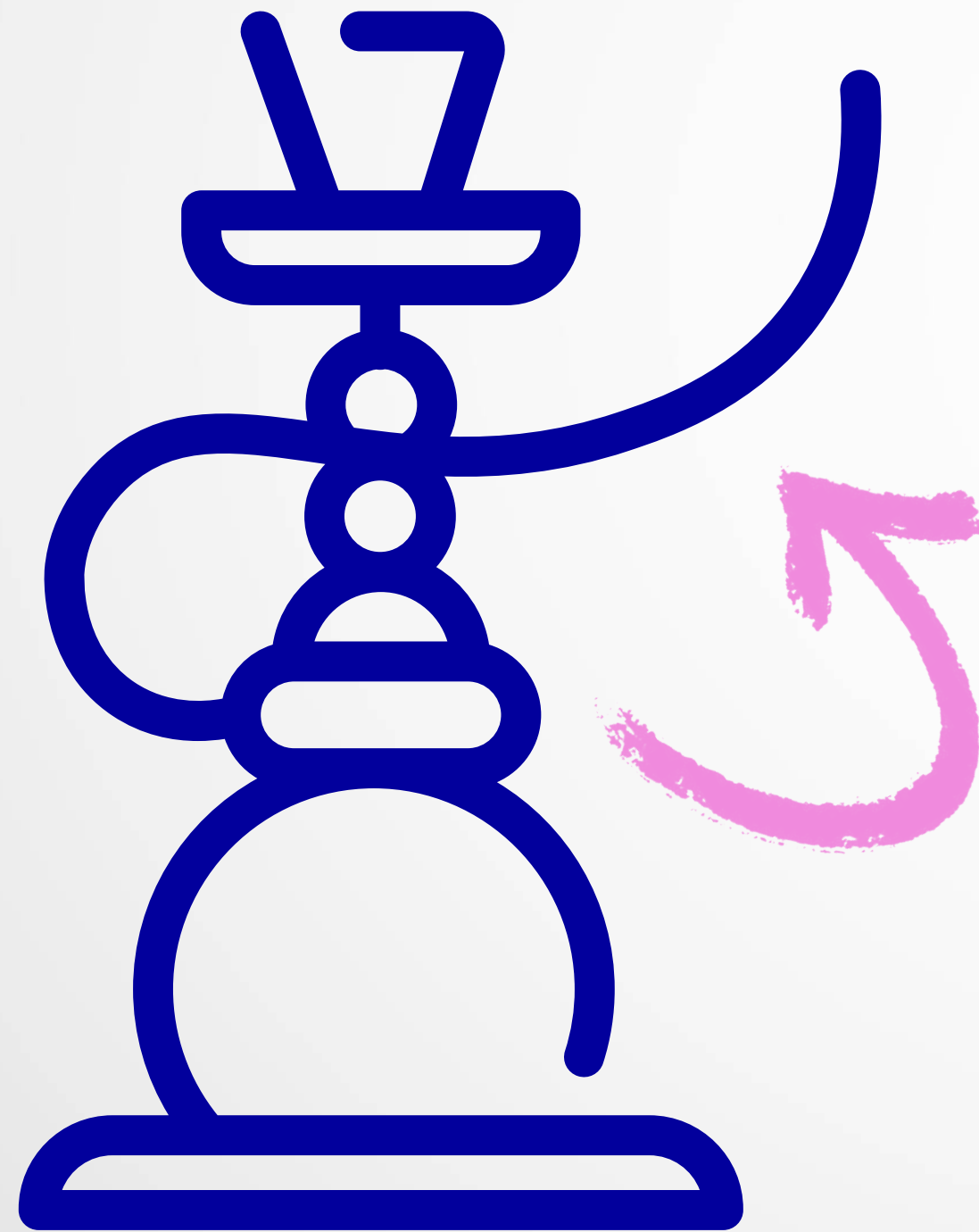

## What does this package offer?

- 5 VIP entrance tickets to the conference for your team members only;
- 5 silver tickets for affiliates;
- 1 X-banner 180\*80 with your logo and QR code placed in the event venue;
- branded tags on each hookah;
- branded hookah menu;
- free hookah for guests at the afterparty;
- your logo on the press wall of the photo zone;
- staff members in branded T-shirts with your company logo;
- watermarked photos and videos from the event with your logo;
- your logo on the press wall of the photo zone;
- amazing atmosphere and networking during the party;
- sponsorship announcement on the website + social media (audience of 60k+ marketers).

**DIAMOND SPONSOR**

**USD 4500 FOR AFTERPARTY**

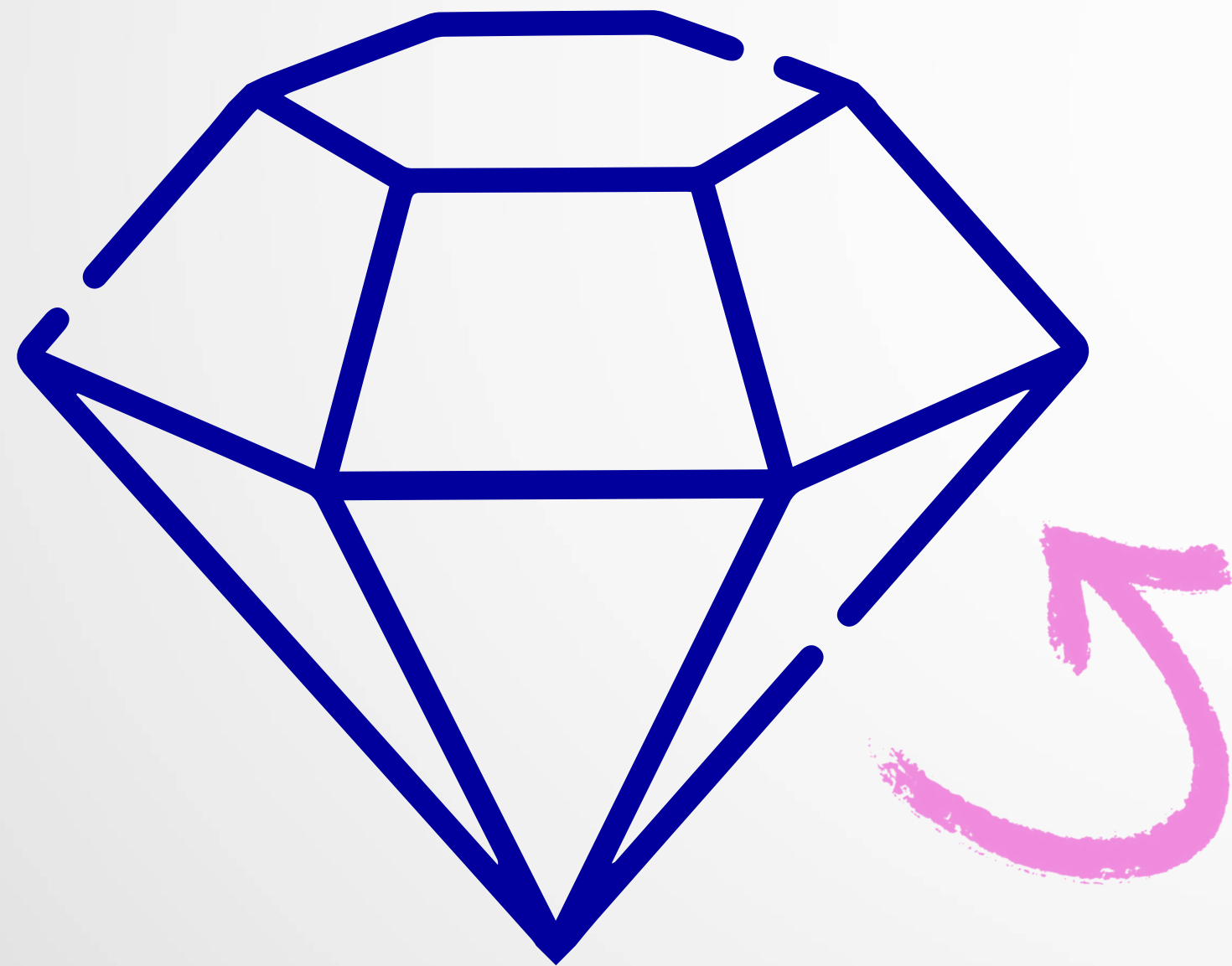

### **What does this package offer?**

- 6 VIP entrance tickets to the conference for your team members only;
- afterparty VIP table for 6 persons with luxury alcohol and snacks, private hookah for your team;
- 1 X-banner 180\*80 with your logo and QR code placed in the afterparty venue;
- your logo on the press wall of the photo zone;
- watermarked photos and videos from the event with your logo;
- amazing atmosphere and networking during the party;
- sponsorship announcement on the website + social media (audience of 60k+ marketers).

WELCOME DRINK

## SPONSOR FOR AFTERPARTY

USD 4000



### What does this package offer?

- 5 VIP entrance tickets for your team members only;
- 5 silver tickets for affiliates;
- glasses with your logo for all guests in the welcome drink zone;
- watermarked photos and videos with your logo after the event;
- your logo on the press wall of the photo zone;
- amazing atmosphere and networking party;
- sponsorship announcement on the website + social media (audience of 60k+ marketing managers).



## **BARMEN SHOW SPONSOR**

**USD 2000**

### **What does this package offer?**

- branded show desk;
- branded bartender T-shirts with your logo;
- amazing atmosphere and networking during the party;
- sponsorship announcement (website + social media).

## **PHOTO BOOTH SPONSOR**

**USD 2000**

### **What does this package offer?**

- branded photo booth;
- photo booth with your logo on pictures at the Conference
- amazing atmosphere and networking during the party;
- sponsorship announcement (website + social media).

## **PHOTOZONE BULLET-TIME SPONSOR**

**USD 2000**

### **What does this package offer?**

- branded photo zone with a special bullet-time system;
- photo booth with your logo on pictures at the Conference
- amazing atmosphere and networking during the party;
- sponsorship announcement (website + social media).

# CONFERENCE

## MEDIA HUB

**USD 12000**

THE CONFERENCE MEDIA HUB OFFERS A VARIETY OF CONTENT INCLUDING LIVE STREAMS, RECORDED SESSIONS, INTERVIEWS, AND PROMOTIONAL VIDEOS. BY CENTRALIZING ALL MEDIA ASSETS, IT PROVIDES CONVENIENT ACCESS TO ATTENDEES BEFORE, DURING, AND AFTER THE EVENT.

- LIVE STREAMING ON YOUTUBE DURING THE CONFERENCE;
- INTERACTIVE FEATURES: Q&A SESSIONS WITH CONFERENCE SPEAKERS DURING THE CONFERENCE;
- BRANDING AND CUSTOMIZATION OF THE CONFERENCE MEDIA HUB (5 SQUARE METERS IN THE CONFERENCE LOUNGE AREA);
- 2 X-BANNER 180\*80 WITH YOUR LOGO AND QR CODE;
- 2 BRANDED T-SHIRTS;
- 1 BRANDED MICROPHONE INSIDE THE CONFERENCE MEDIA HUB;
- BRANDED OVERLAY DURING THE LIVE STREAM;
- YOUTUBE DESCRIPTIONS ON THE LIVE STREAM;
- BRANDED LANDING PAGE OF THE LIVE STREAM ON THE CONVERSION CONFERENCE WEBSITE;
- WATERMARKED PHOTOS AND VIDEOS FROM THE CONFERENCE WITH YOUR LOGO;
- YOUR LOGO ON THE PRESS WALL OF THE PHOTO ZONE;
- AMAZING ATMOSPHERE AND NETWORKING DURING THE CONFERENCE;
- SPONSORSHIP ANNOUNCEMENT ON THE WEBSITE + SOCIAL MEDIA (AUDIENCE OF 60K+ MARKETERS);
- 6 VIP TICKETS FOR THE CONFERENCE;
- 2 SILVER TICKETS FOR THE CONFERENCE.



interested? contact us right now!

\*booking deadlines: 7 days before the event



# SILVER STEND

**USD 3000**

## What does this package offer?

- 4 m2 of your space (2x2 m);
- back wall 2 meters wide with LED lamps;
- 1 branded reception desk and a high chair;
- 2 VIP entrance tickets for your team members only;
- 2 silver tickets for affiliates;
- the opportunity to bring your X-banner to the conference venue and print it yourself;
- your logo on the press wall of the photo zone;
- amazing atmosphere and networking during the party;
- sponsorship announcement (website + social media).

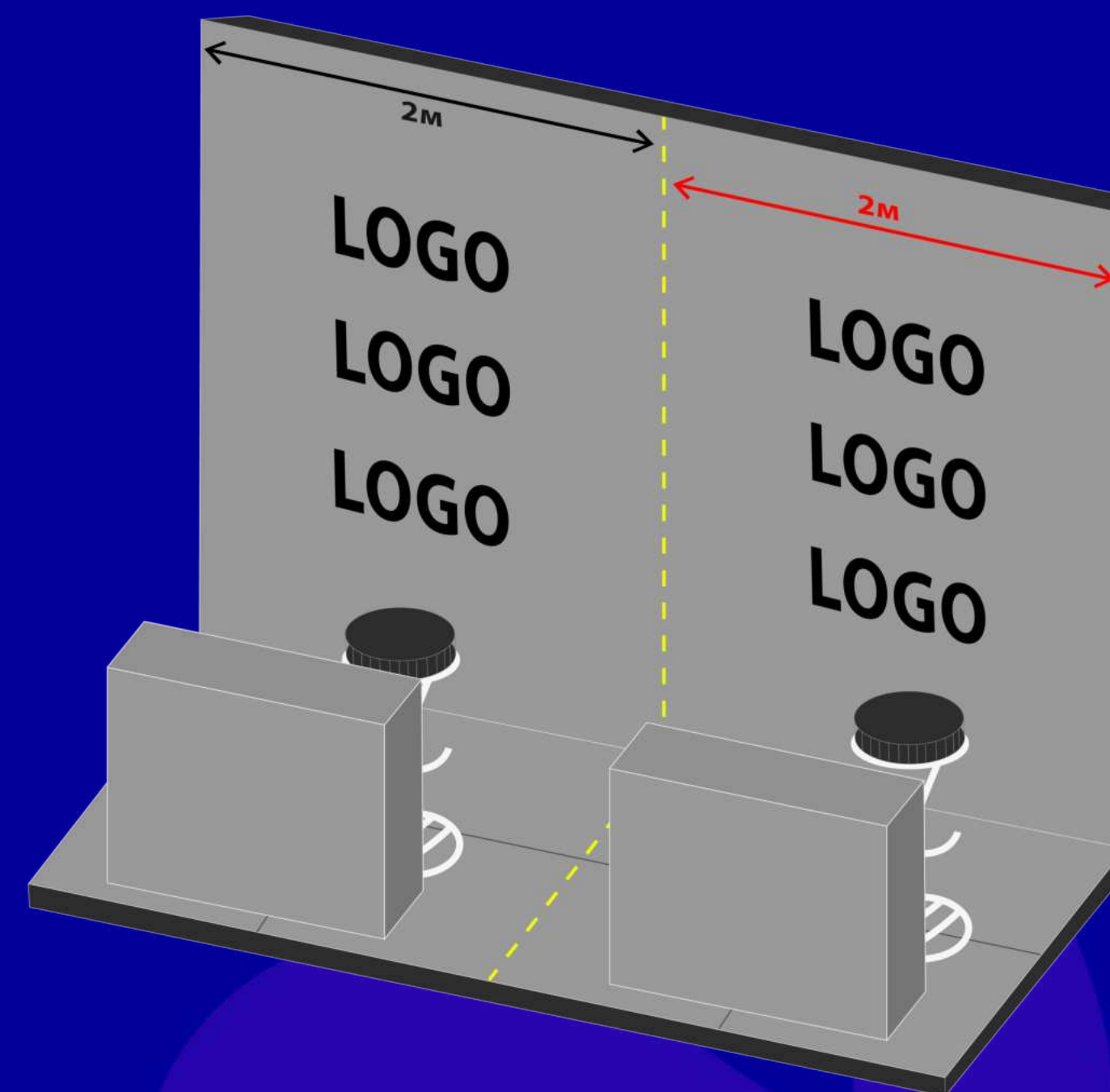

# GOLD STEND

**USD 4500**

## What does this package offer?

- 6 m2 of your space (3x2 m);
- back wall 3 meters wide with LED lamps;
- 1 branded reception desk stand and a high chair;
- 3 VIP entrance tickets for your team members only;
- 3 silver tickets for affiliates;
- the opportunity to bring your own X-banner to the conference venue and print it yourself;
- your logo on the press wall of the photo zone;
- amazing atmosphere and networking during the party;
- sponsorship announcement (website + social media).

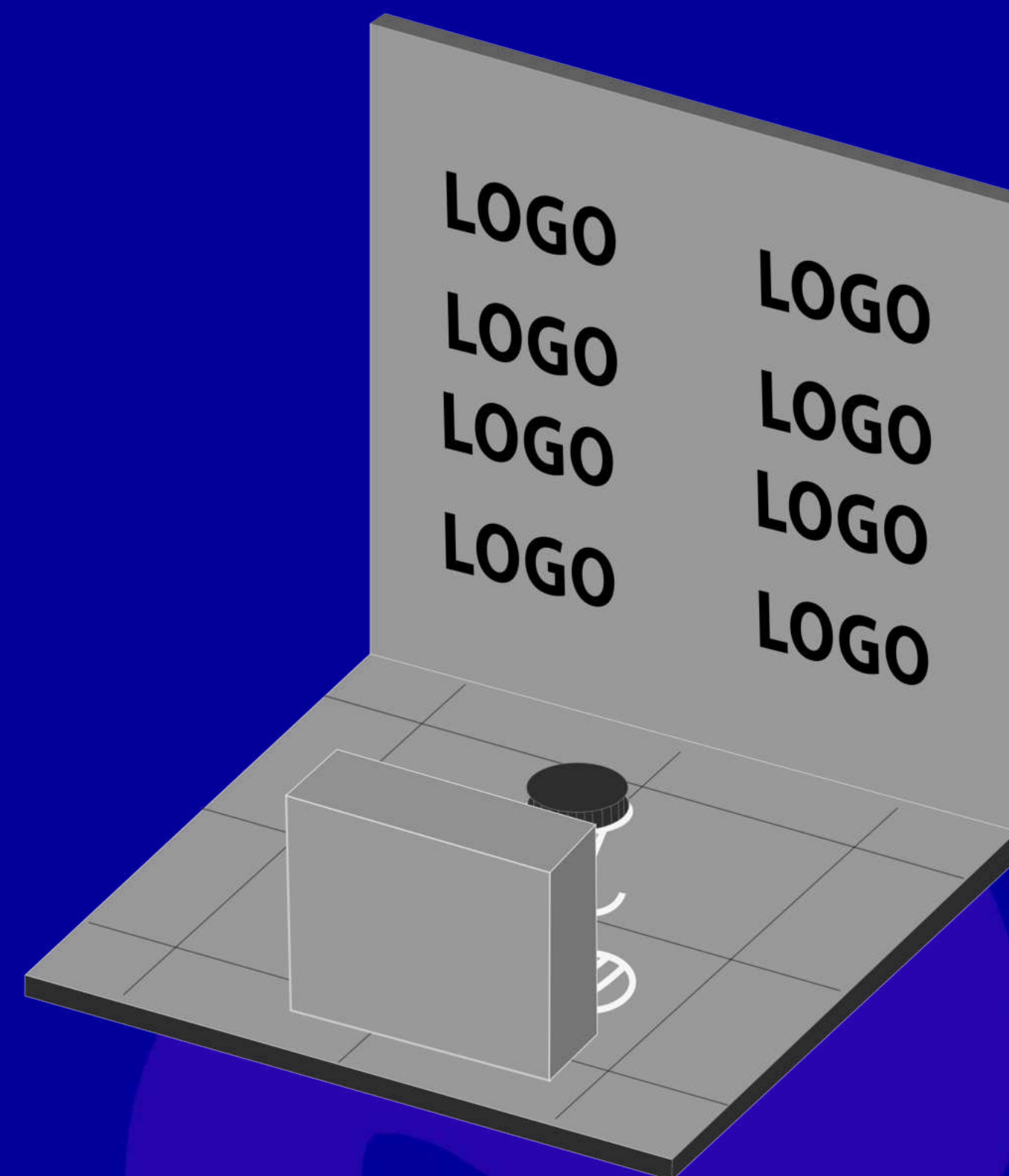

# PLATINUM STEND

**USD 6000**

## What does this package offer?

- 8 m2 of your space (4x2 m);
- back wall 4 meters wide with LED lamps;
- 2 sofas & 1 coffee table;
- 1 branded reception desk;
- 2 high chairs;
- 4 VIP entrance tickets for your team members only;
- 4 silver tickets for affiliates;
- model accreditation (where you bring your promo models and we provide passes for them during the conference);
- the opportunity to bring your X-banner to the conference venue and print it yourself;
- giveaway opportunity;
- your logo on the press wall of the photo zone;
- amazing atmosphere and networking during the party;
- sponsorship announcement (website + social media).

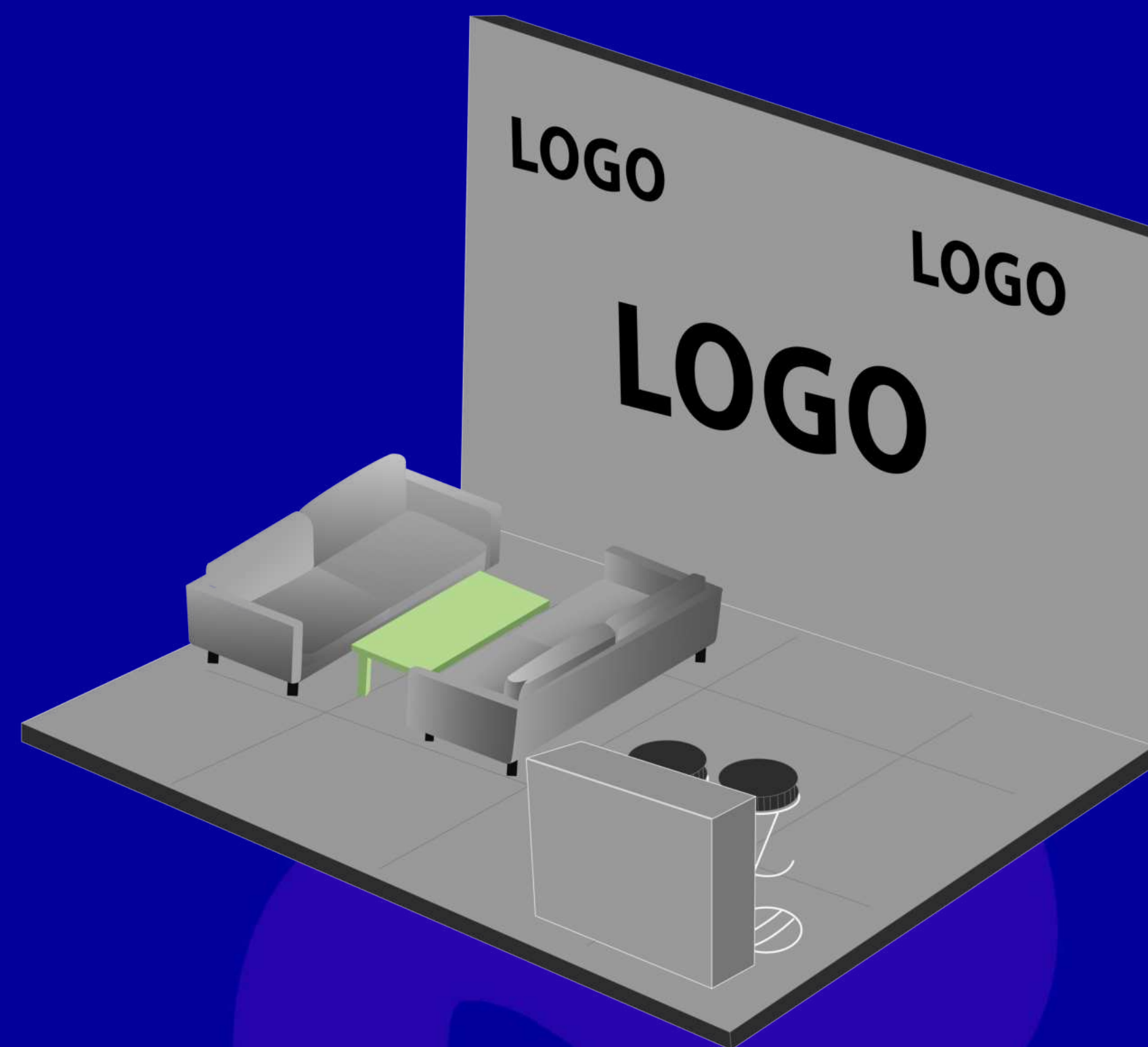

# DIAMOND STEND

**USD 9000**

## What does this package offer?

- 12 m2 of your space (4x3 m);
- back wall 4 meters wide with LED lamps;
- 2 sofas & 1 coffee table;
- 1 branded reception desk;
- 2 high chairs;
- 6 VIP entrance tickets for your team members only;
- 6 silver tickets for affiliates;
- model accreditation (where you bring your promo models and we provide passes for them during the conference);
- the opportunity to bring your X-banner to the conference venue and print it yourself;
- giveaway opportunity;
- your logo on the press wall of the photo zone;
- amazing atmosphere and networking during the party;
- sponsorship announcement (website + social media).

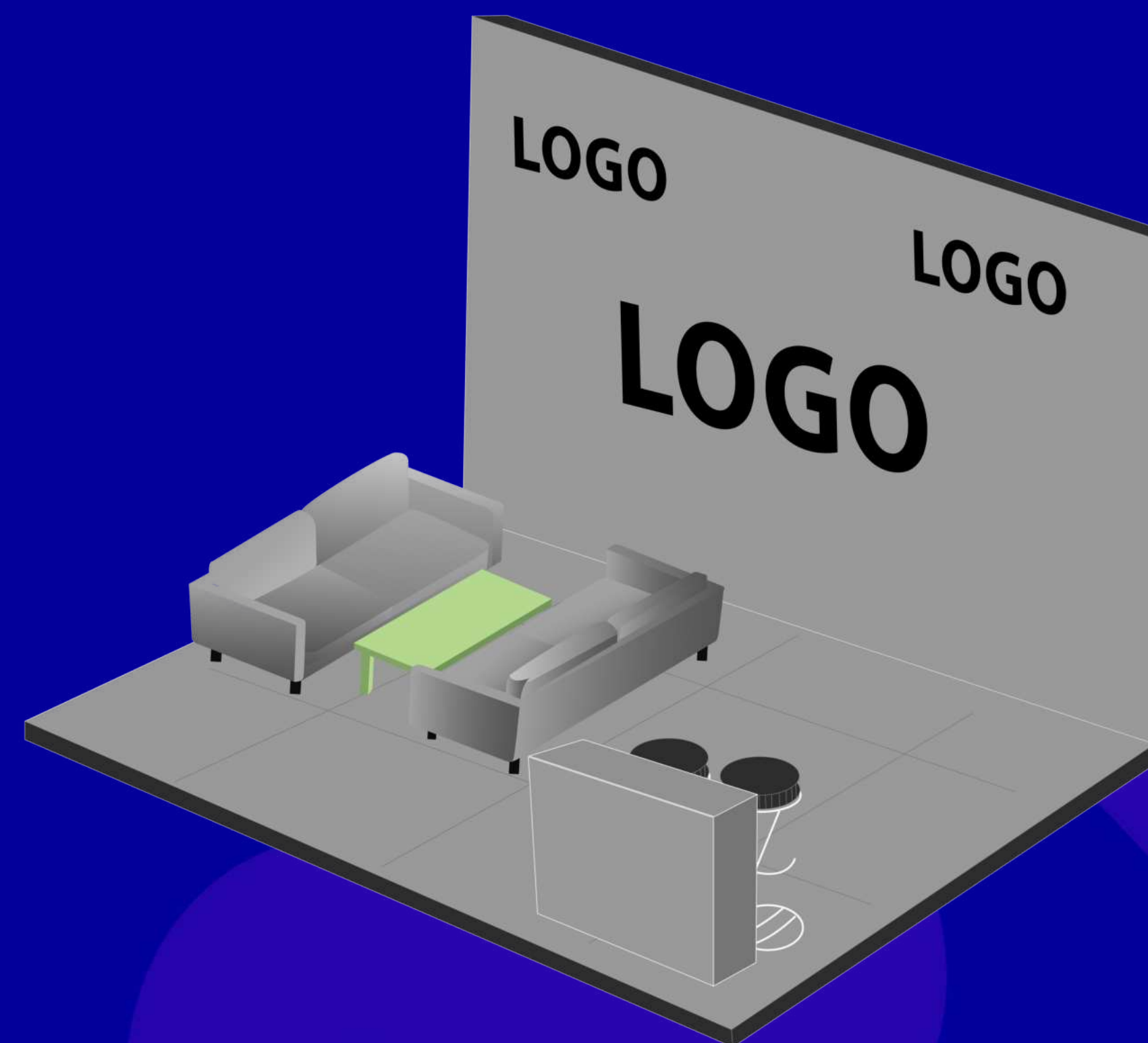

# EXCLUSIVE DIAMOND

## USD 7500

# STEND

### What does this package offer?

- 12 m2 of your space (4x3 m)
- 6 VIP entrance tickets for your team members only;
- 6 silver tickets for affiliates;
- model accreditation (where you bring your promo models and we provide passes for them during the conference);
- the opportunity to bring your X-banner to the conference venue and print it yourself;
- giveaway opportunity;
- your logo on the press wall of the photo zone;
- amazing atmosphere and networking during the party; sponsorship announcement (website + social media).

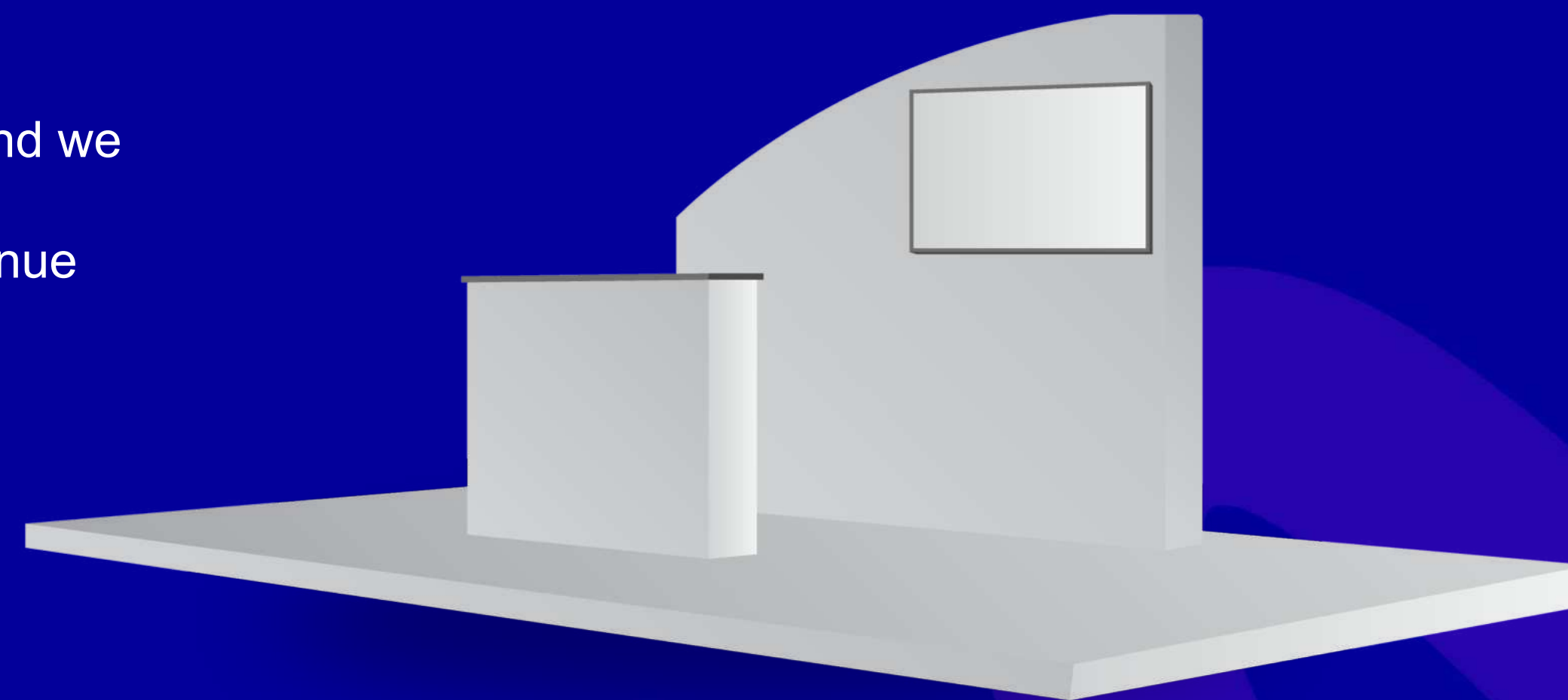

# GENERAL STEND

**USD 13000**

## What does this package offer?

- 18 m2 of your space (6x3 m);
- back wall 6 meters wide with LED lamps;
- 4 sofas & 2 coffee table;
- 1 branded reception desk;
- 2 high chairs;
- 10 VIP entrance tickets for your team members only;
- 6 silver tickets for affiliates;
- model accreditation (where you bring your promo models and we provide passes for them during the conference);
- the opportunity to bring your X-banner to the conference venue and print it yourself;
- giveaway opportunity;
- your logo on the press wall of the photo zone;
- amazing atmosphere and networking during the party;
- sponsorship announcement (website + social media).

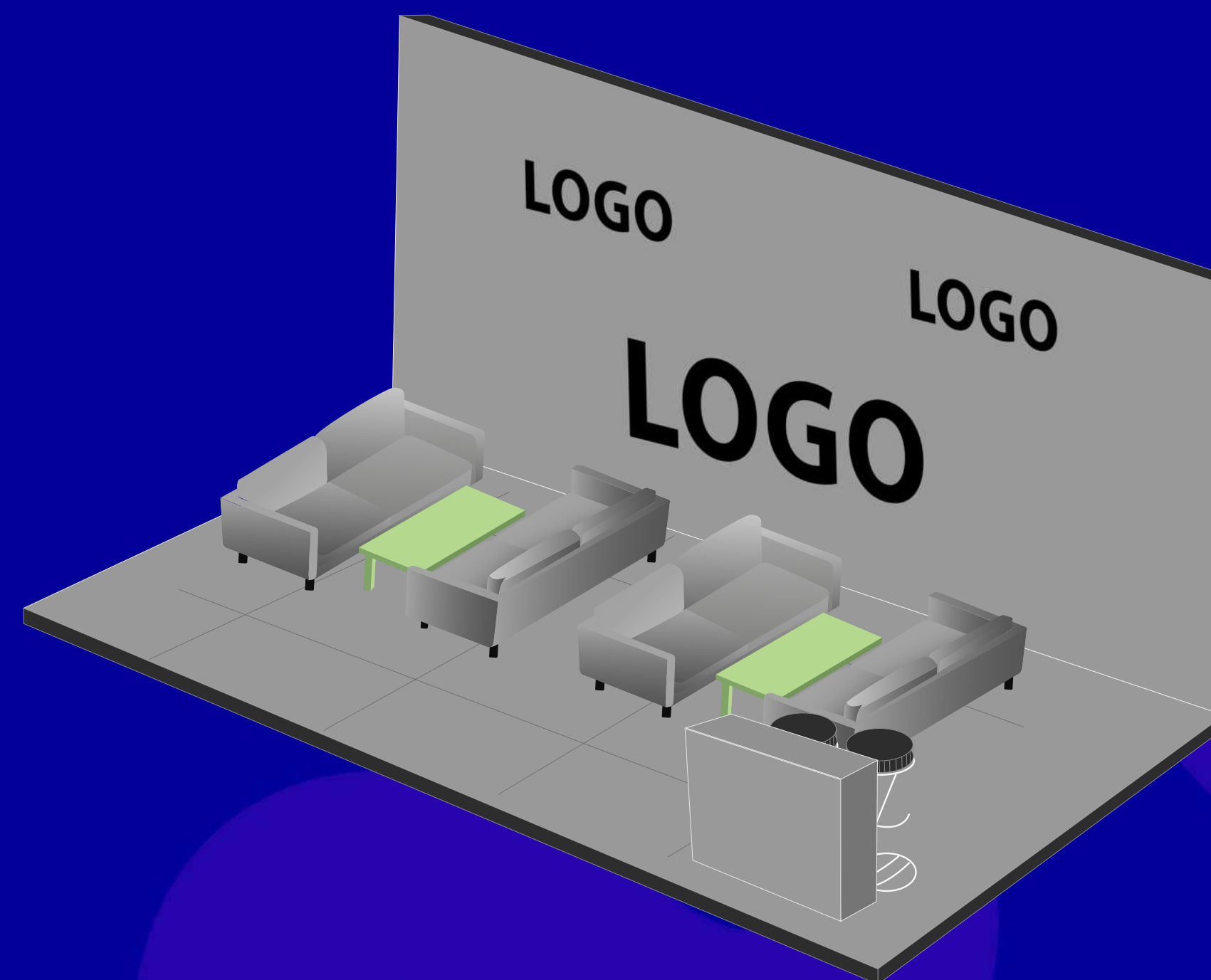

**EXCLUSIVE GENERAL**

**USD 11000**

**STAND**

### **What does this package offer?**

- 18 m2 of your space (6x3 m);
- 10 VIP entrance tickets for your team members only;
- 6 silver tickets for affiliates;
- model accreditation (where you bring your promo models and we provide passes for them during the conference);
- the opportunity to bring your X-banner to the conference venue and print it yourself;
- giveaway opportunity;
- your logo on the press wall of the photo zone;
- amazing atmosphere and networking during the party; sponsorship announcement (website + social media).

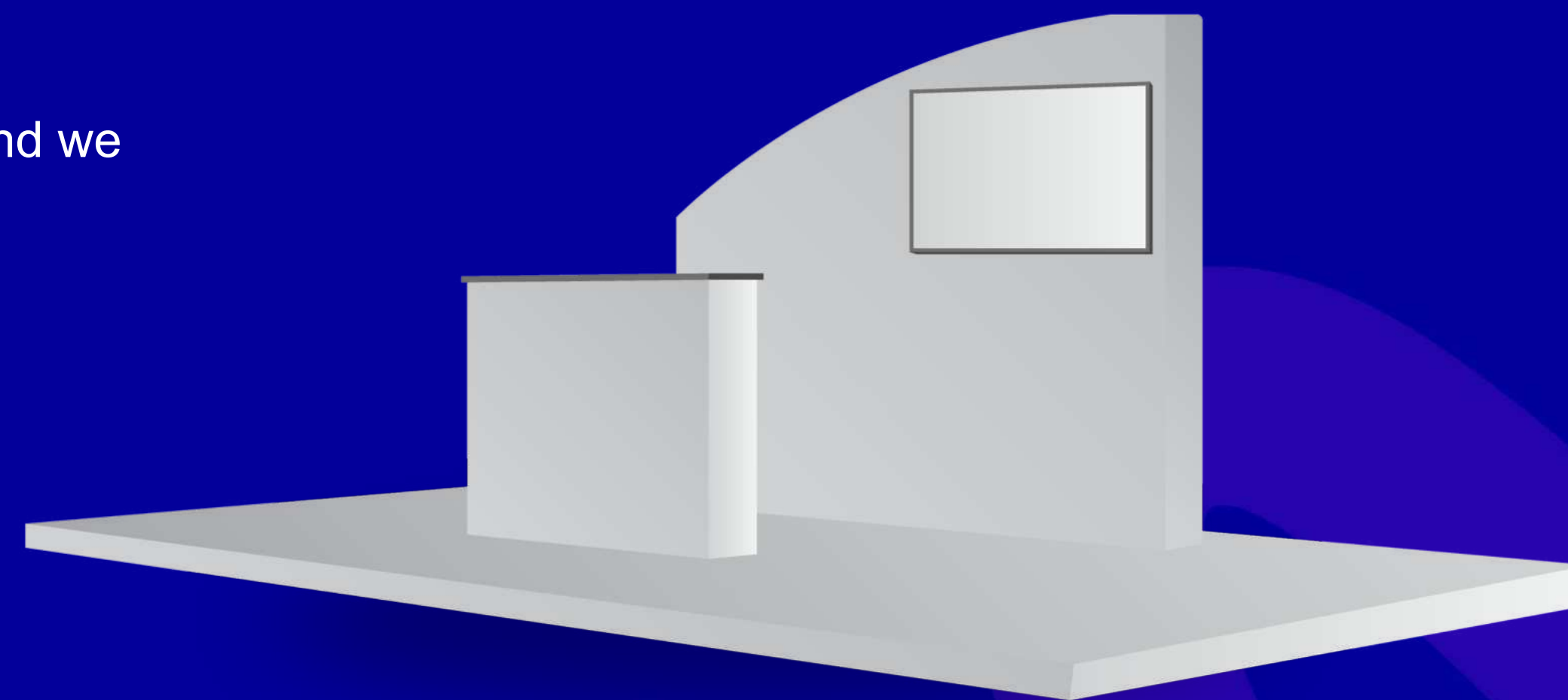

**THANK YOU FOR YOUR INTEREST!**

**WE ARE DELIGHTED TO HAVE A PARTNERSHIP FOR THE CONVERSION CONF.**

SEE YOU THERE TO LISTEN TO EXPERT SPEECHES AND ENGAGE IN VALUABLE NETWORKING.  
SO GET READY TO ROCK KYIV AND PREPARE YOURSELF FOR THE NEXT CONVERSION CONF!

**FOR MORE INFORMATION ABOUT CONVERSION CONF, VISIT:**

<https://www.conversion-conf.com/>

**TO STAY UPDATED WITH CONVERSION CLUB AND GAIN MORE INSIGHTS,  
CHECK OUT OUR WEBSITE:**

<https://www.conversion-club.com/schedule-affiliate-events-2024>



**KARYNA**

**SALES**

**@salescc2021**



**VLADIMIR**

**SALES**

**@conversion\_conf\_sales**